

EchoPod DL14, DL24 & DL34 Series Manual Revision A.3



**Flowline Inc.
10500 Humbolt Street
Los Alamitos, CA 90720
Tel: (562) 598-3015
Fax: (562) 431-8507
www.flowline.com**

Preface

This manual explains how to use the EchoPod DL14, DL24 and DL34 series level switch, controller and transmitter.

Warranty, Service & Repair

To register your product with the manufacturer, go to the Flowline website for on-line registration. The website address is as follows:

www.flowline.com

On-line Warranty Registration can be found on the Flowline home page.

If for some reason your product must be returned for factory service, go to the Flowline website to receive a Material Return Authorization number (MRA), providing the following information:

1. Full Part Number, Full Serial Number
2. Name and telephone number of someone who can answer technical questions related to the product and its application.
3. Return Shipping Address
4. Brief Description of the Symptom
5. Brief Description of the Application

On-line Material Return Authorization can be found under Contact Us in the Navigation Bar along the side of the home page. Click on *Return Authorization* to begin the MRA request. Once you have received a MRA number, ship the product prepaid in its original packing to:

Flowline Factory Service
MRA_____

10500 Humbolt Street
Los Alamitos, CA 90720

To avoid delays in processing your repair, write the MRA on the shipping label. Please include the information about the malfunction with your product. This information enables our service technicians to process your repair order as quickly as possible.



Warranty

Flowline warrants to the original purchaser of its products that such products will be free from defects in material and workmanship under normal use and service in accordance with instructions furnished by Flowline for a period, which is equal to the shorter of one year from the date of purchase of such products or two years from the date of manufacture of such products. Flowline's obligation under this warranty is solely and exclusively limited to the repair or replacement, at Flowline's option, of the products or components, which Flowline's examination determines to its satisfaction to be defective in material or workmanship within the warranty period. Flowline must be notified pursuant to the instructions below of any claim under this warranty within thirty (30) days of any claimed lack of conformity of the product. Any product repaired or replaced under this warranty will be warranted only for the remainder of the original warranty period.

Returns

Products cannot be returned to Flowline without Flowline's prior authorization. To return a product that is thought to be defective, go to www.flowline.com, and submit a customer return (MRA) request form and follow the instructions therein. All warranty and non-warranty product returns to Flowline must be shipped prepaid and insured. Flowline will not be responsible for any products lost or damaged in shipment.

Limitations

This warranty does not apply to products which: 1) are beyond the warranty period or are products for which the original purchaser does not follow the warranty procedures outlined above; 2) have been subjected to electrical, mechanical or chemical damage due to improper, accidental or negligent use; 3) have been modified or altered; 4) anyone other than service personnel authorized by Flowline have attempted to repair; 5) have been involved in accidents or natural disasters; or 6) are damaged during return shipment to Flowline. Flowline reserves the right to unilaterally waive this warranty and dispose of any product returned to Flowline where: 1) there is evidence of a potentially hazardous material present with the product; or 2) the product has remained unclaimed at Flowline for more than 30 days after Flowline has dutifully requested disposition. This warranty contains the sole express warranty made by Flowline in connection with its products. **ALL IMPLIED WARRANTIES, INCLUDING WITHOUT LIMITATION, THE WARRANTIES OF MERCHANTABILITY AND FITNESS FOR A PARTICULAR PURPOSE, ARE EXPRESSLY DISCLAIMED.** The remedies of repair or replacement as stated above are the exclusive remedies for the breach of this warranty. **IN NO EVENT SHALL FLOWLINE BE LIABLE FOR ANY INCIDENTAL OR CONSEQUENTIAL DAMAGES OF ANY KIND INCLUDING PERSONAL OR REAL PROPERTY OR FOR INJURY TO ANY PERSON. THIS WARRANTY CONSTITUTES THE FINAL, COMPLETE AND EXCLUSIVE STATEMENT OF WARRANTY TERMS AND NO PERSON IS AUTHORIZED TO MAKE ANY OTHER WARRANTIES OR REPRESENTATIONS ON BEHALF OF FLOWLINE.** This warranty will be interpreted pursuant to the laws of the State of California. If any portion of this warranty is held to be invalid or unenforceable for any reason, such finding will not invalidate any other provision of this warranty.

Introduction:

The EchoPod is a general-purpose ultrasonic level switch, controller and transmitter that provides a loop powered 4-20 mA output and 4 SPST 60 VA relays. The 4-20 mA output can be used to provide the proportional level of liquid in any tank or vessel. The 4 relays can be used to control multiple combinations of pumps, valves and/or alarms. The signal can be connected to any device that accepts a loop powered 4-20 mA signal or relay output, such as a PLC, SCADA, DCS, display, controller, etc.

New Features

- Simple configuration with WebCal software, *no more target calibration*
- Adjustable Loop Fail-Safe, Hold Last, Empty, Full, 21 mA, 22 mA
- Easy to reverse mA output, 4-20 mA to 20-4 mA
- Adjustable start-up condition, Empty, Mid (12 mA), Full, Over range (22 mA)
- Increased output filtering

Table of Contents

Introduction	4
New Features	4
About this manual	5
Specifications	7
Dimensions	7
Getting Started	8
USB® Fob Interface	8
WebCal	9
Step 1: Configuration	9
Step 2: Tank Levels	17
Step 3: Write to Unit	17
Wiring	18
Wiring EchoPod	18
Wire Connections	18
Installation	20
Mounting Guide	20
Fitting Selection	21
Tank Adapter	22
Riser	22
Flange	22
Side Mount Fitting	23
Stand Pipe	23
Advanced Feature	24
Appendix	26
Updating WebCal Software	26
Updating Transmitter Firmware	26
Factory Defaults	27
Troubleshooting	29

FLOWLINE

About this Manual:

PLEASE READ THE ENTIRE QUICK START PRIOR TO INSTALLING OR USING THIS PRODUCT. This manual includes information on the EchoPod series Ultrasonic Level Switch, controller and transmitter from FLOWLINE. Please refer to the part number located on the switch label to verify the exact model configuration, which you have purchased.

User's Responsibility for Safety:

FLOWLINE manufactures a broad range of level sensing technologies. While each of these sensors is designed to operate in a wide variety of applications, it is the user's responsibility to select a sensor model that is appropriate for the application, install it properly, perform tests of the installed system, and maintain all components. The failure to do so could result in property damage or serious injury.

Proper Installation and Handling:

Only professional staff should install and/or repair this product. Install the transmitter with the included Viton® gasket and never over tighten the transmitter within the fitting. Always check for leaks prior to system start-up.

Wiring and Electrical:

A supply voltage of 12 to 28 VDC is used to power the EchoPod. Electrical wiring of the transmitter should be performed in accordance with all applicable national, state, and local codes.

Material Compatibility:

The enclosure is made of Polycarbonate (PC). The transducer is made of Polyvinylidene Fluoride (PVDF). Make sure that the model, which you have selected, is chemically compatible with the application media.

Enclosure:

While the transmitter housing is liquid-resistant the EchoPod is not designed to be operational when immersed. It should be mounted in such a way that the enclosure and transducer do not come into contact with the application media under normal operational conditions.

Safety:

- Installation should be done by properly trained staff
- Supply voltage should never exceed a maximum of 28 VDC
- Make sure the sensor is chemically compatible with your application
- Design a fail-safe system that accommodates the possibility of sensor and/or power failure
- This sensor should not be used in classified hazardous environments

Make a Fail-Safe System:

Design a fail-safe system that accommodates the possibility of transmitter and/or power failure. FLOWLINE recommends the use of redundant backup systems and alarms in addition to the primary system.

Flammable, Explosive or Hazardous Applications:

EchoPod should not be used within classified hazardous environments.

Warning:

Always use the Viton® gasket when installing the EchoPod, and make sure that all electrical wiring of the switch is in accordance with applicable codes.

Components:

EchoPod is offered in two different models. Depending on the model purchased, you may or may not have been shipped all the components shown below. You do however, need an EchoPod, USB® Fob and Viton® gasket to configure, install and operate EchoPod.

- EchoPod
 - DL14-00 – 4.1' (1.25 m) range, Type 6P encl., 1" NPT
 - DL14-01 – 4.1' (1.25 m) range, Type 6P encl., 1" NPT w/ Fob
 - DL14-10 – 4.1' (1.25 m) range, Type 6P encl., 1" G
 - DL14-11 – 4.1' (1.25 m) range, Type 6P encl., 1" G w/ Fob
 - DL24-00 – 9.8' (3.0 m) range, Type 6P encl., 1" NPT
 - DL24-01 – 9.8' (3.0 m) range, Type 6P encl., 1" NPT w/ Fob
 - DL24-10 – 9.8' (3.0 m) range, Type 6P encl., 1" G
 - DL24-11 – 9.8' (3.0 m) range, Type 6P encl., 1" G w/ Fob
 - DL34-00 – 18.0' (5.5 m) range, Type 6P encl., 2" NPT
 - DL34-01 – 18.0' (5.5 m) range, Type 6P encl., 2" NPT w/ Fob
 - DL34-10 – 18.0' (5.5 m) range, Type 6P encl., 2" G
 - DL34-11 – 18.0' (5.5 m) range, Type 6P encl., 2" G w/ Fob
- Viton® Gasket
 - Part #200128 – used with DL14 series
 - Part #200129 – used with DL24 series
 - Part #204038 – used with DL34 series
- USB® Fob (DL_4-_1 only)
 - Part #LI99-1001
- Quick Start Guide

FLOWLINE

Specifications:

Range:	DL14: 2" to 4.1' (5 cm to 1.25m) DL24: 4" to 9.8' (10 cm to 3.0m) DL34: 8" to 18.0' (20 cm to 5.5m)	Relay fail-safety:	Power loss: Hold last Echo loss: Open, close or hold last
Accuracy:	DL14: 0.125" (3mm) DL24: +/- 0.2% of range DL34: +/- 0.2% of range	Hysteresis:	Selectable
Resolution:	DL14: 0.019" (0.5mm) DL24: 0.039" (1mm) DL34: 0.079" (2mm)	Configuration:	WebCal® PC Windows® USB 2.0
Beam width:	DL14/24: 2" (5cm) dia. DL34: 3" (7.6cm)	Temp. comp.:	Automatic
Dead band:	DL14: 2" (5 cm) DL24: 4" (10 cm) DL34: 8" (20 cm)	Process temp.:	F: 20° to 140° C: -7° to 60°
Memory:	Non-volatile	Ambient temp.:	F: 31° to 140° C: -35° to 60°
Supply voltage:	24 VDC (loop)	Pressure:	MWP = 30 PSI
Loop resistance:	400 Ohms max	Enclosure type:	Type 6P encapsulated, corrosion resistance & submersible
Consumption:	0.5 W	Encl. material:	PC
Signal output:	4-20 mA, two-wire (when loop powered)	Strain relief mat.:	Santoprene
Contact type:	(4) SPST relays 1A	Trans. material:	PVDF
Loop fail-safety:	4 mA, 20 mA, 21 mA, 22 mA or hold last	Cable length:	48" (1.2 m)
		Cable jacket mat.:	Polyurethane
		Cable type:	9-cond., shielded
		Process mount:	DL14/24: 1" NPT (1" G) DL34: 2" NPT (2" G)
		Mount. gasket:	Viton®
		Classification:	General purpose
		Compliance:	RoHS
		Approvals:	CE – DL14/DL24/DL34 cFMus – DL14 only

Dimensions:

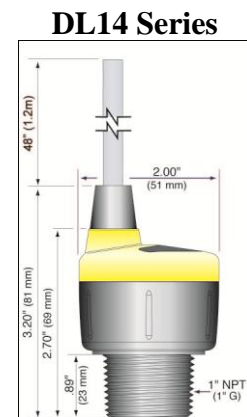
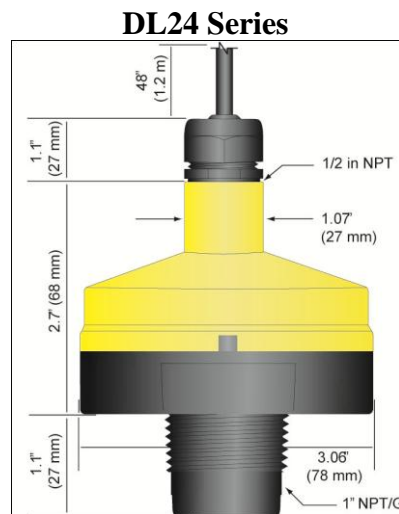
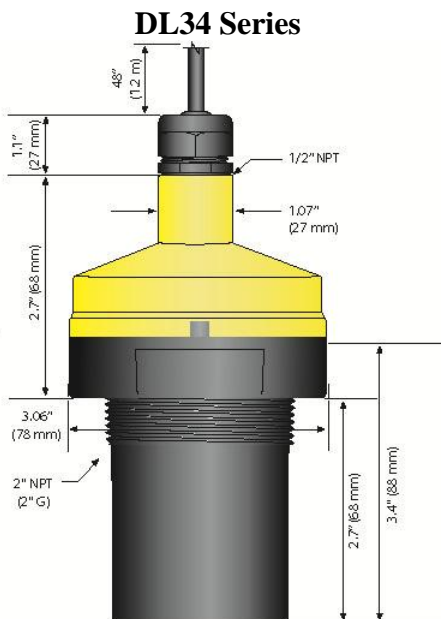

Getting Started:

EchoPod is configured through WebCal, a PC software program. WebCal is a free download from Flowline's website. **You must download and install WebCal prior to plugging in the USB® Fob.** Please go to <http://www.flowline.com>, click on WebCal Software and select your language version.

Configuration

The level sensor is configurable via our free WebCal PC software and Fob USB adapter. The sensors are offered with and without Fobs. Fobs are universal and can be used to configure any WebCal compatible product. Download your free copy of WebCal in English or Chinese.

Select from simple pre-programmed drop-down menus

Set-points are customized to your application

Visual representation of your configuration

Create, view & print your custom PDF wiring diagram

Save & load your configuration for revision control

Easy Configuration

- 169 different configurations
- Graphical configuration interface
- Install and test configuration in seconds
- PDF wiring diagram for each configuration
- Technical help menu with tips and glossary

Revision Control

- Save configuration files for future use or reference
- Print wiring diagram and configuration text files
- Email configuration files to other remote users

System Requirements

- Windows® XP & 2000
- USB® 2.0
- 10 mB hard disk space
- 256 mB RAM

Free Download

English Version

Chinese Version

WebCal System Requirements

Windows® XP or 2000
 10 mB hard drive space
 256 mB RAM
 1 USB® 2.0 port
 Internet connection

USB® Fob Interface

EchoSonic communicates with WebCal through a USB® interface called a Fob. Before plugging your Fob into your computer's USB® port, be sure that you have installed WebCal on your computer.

Connect the red, green, white and black wires from EchoPod into the correct terminals on the Fob. Tighten the screws on the terminals and plug your Fob into the USB® port of your computer.

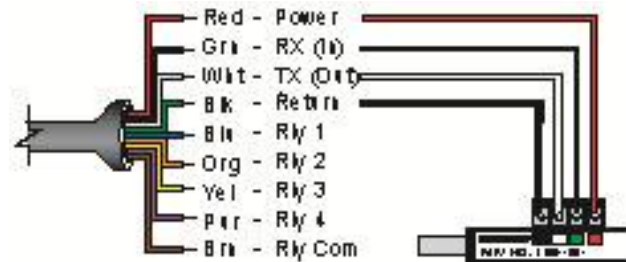

Wiring identical for all series

FLOWLINE

- * Once EchoPod is configured and prior to installation, isolate the white and green wires from active power to prevent a short of the configuration circuit

WebCal

With EchoPod connected to your computer, open the WebCal software by clicking on the WebCal icon. Follow steps 1-3 to configure the transmitter. Click “Help” in the lower right hand corner and open the help menu of WebCal for additional instructions on WebCal. If you need additional assistance using WebCal, please contact a Flowline Applications engineer at (562) 598-3015

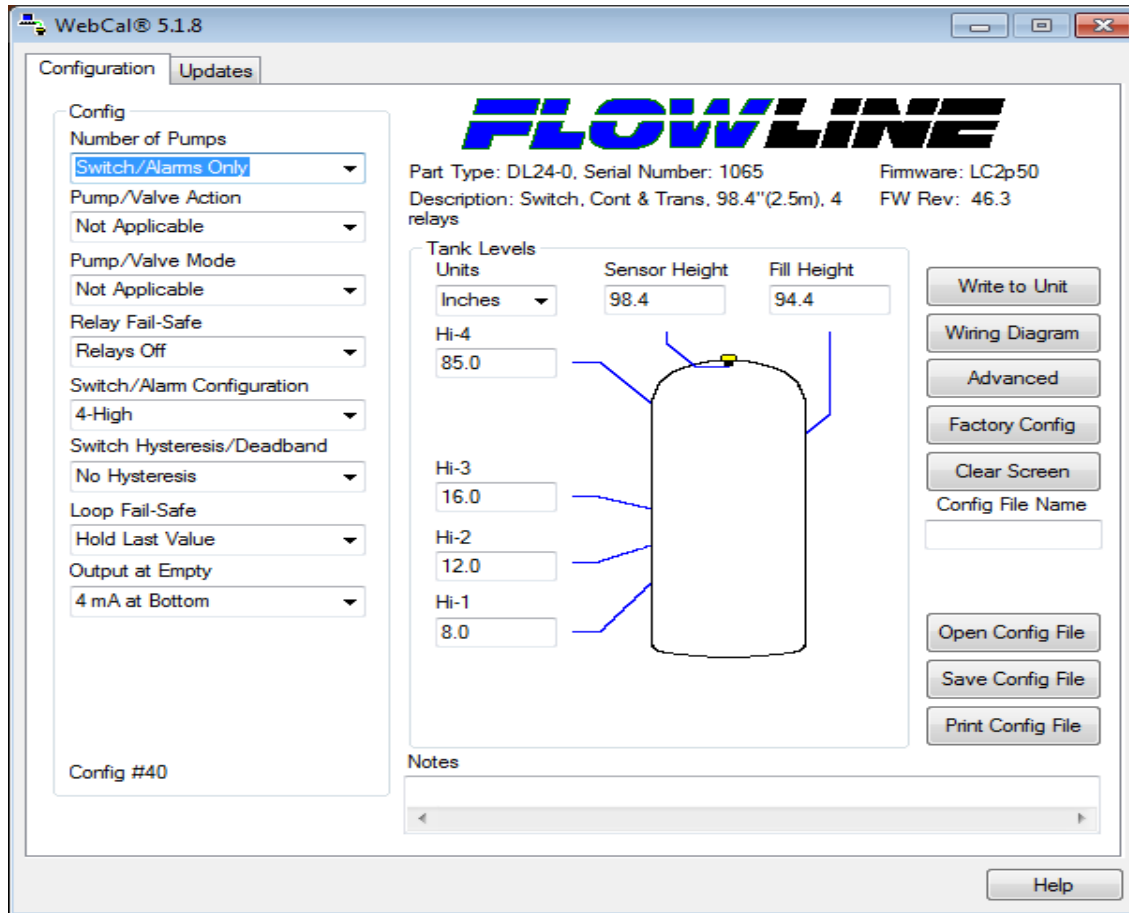

WebCal Step 1: Configuration

This section of WebCal is where you select the application’s configuration settings. Start from the top and work to the bottom, choosing the selections that are applicable to your configuration. “**Not Applicable**” will automatically show when a selection doesn’t apply to your configuration settings, and you may move on. All configuration settings must be selected or have “**Not Applicable**” before you can continue to step 2. **Note:** Pressing the Clear Screen button will reset the configuration table and allow access to all of the features.

Configuration Updates

Config

Number of Pumps 

Switch/Alarms Only

Pump/Valve Action

Not Applicable

Pump/Valve Mode

Not Applicable

Relay Fail-Safe

-please select-

Switch/Alarm Configuration

-please select-

Switch Hysteresis/Deadband

-please select-

Loop Fail-Safe

-please select-

Output at Empty

-please select-

Continue to select

Number of Pumps

This feature allows you to select the number of pumps or valves used with EchoPod. This is the setting that activates the control capabilities of up to two relays. Control relays are often referred to as Latching relays.

- **Switch/Alarms Only** – The relays will be standard single point relays (High and/or Low alarms). Relays are non-latching.
- **1- Pump/Valve** – One relay will be configured as a control or latching relay (relay will have a start level and a separate stop level). Use this setting to control one pump or valve for automatic filling or emptying of a tank.
- **2-Pumps/Valves** – Two relays are configured as control or latching relays. Each relay will have a unique start level and a common stop level. Use this setting to control two pumps or valves for automatic filling or emptying of a tank.
- **4-20mA Transmitter Only** – This setting will disengage all of the relays. Use this function if you are not using any relays and using only the 4-20 mA current output.

Note: Right click on any menu that you may have questions on to open the help menu.

Note: To reset, press the Clear Screen button.

FLOWLINE

Configuration Updates

Config

Number of Pumps
1-Pump/Valve

Pump/Valve Action
Empties Tank

Pump/Valve Mode
Simplex

Relay Fail-Safe
-please select-

Switch/Alarm Configuration
-please select-

Switch Hysteresis/Deadband
-please select-

Loop Fail-Safe
-please select-

Output at Empty
-please select-

Continue to select

Pump/Valve Action

This feature allows you to select if the pumps or valves will be used to automatically fill or empty the tank. For 2-Pump/Valve mode, both devices must be the same (automatic fill or empty). You cannot set one relay for fill and the other for empty.

- **Empties Tank** – Will set relay(s) to automatically empty a tank. Start level will be above the Stop level for each relay.
- **Fills Tank** – Will set relay(s) to automatically fill a tank. Start level will be below the Stop level for each relay.
- **Not Applicable** – Appears when this function is not available (such as when **Switch/Alarms Only** or **4-20mA Transmitters Only** are selected).

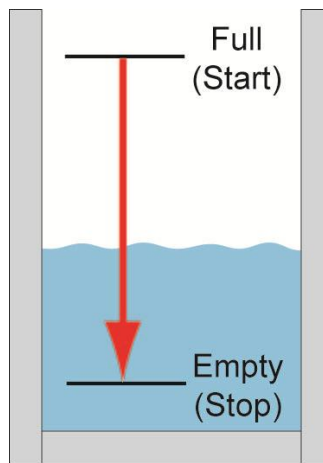

**Empties Tank
(Auto Empty)**

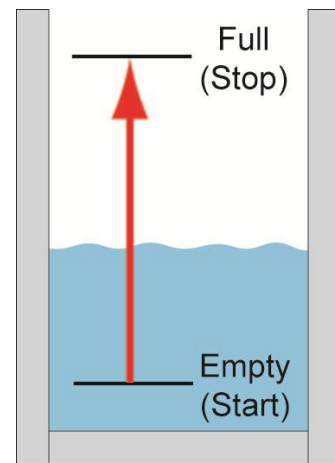

**Fills Tank
(Auto Fill)**

Note: Right click on any menu that you may have questions on to open the help menu.

Note: To reset, press the Clear Screen button.

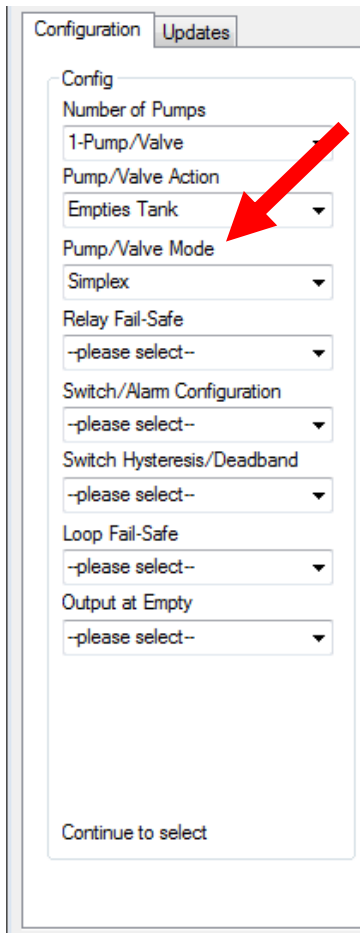

Pump/Valve Mode

This feature allows you to select the mode for a control or latching relay. Pump/Valve mode is not active for Switch/Alarms Only or 4-20 mA Transmitter Only.

- **Simplex** – Allows for the relay to be used as an automatic fill or empty. This is the default and only configuration when *1-Pump/Valve* is selected.

- **Simplex used to Empty Tank (example)**

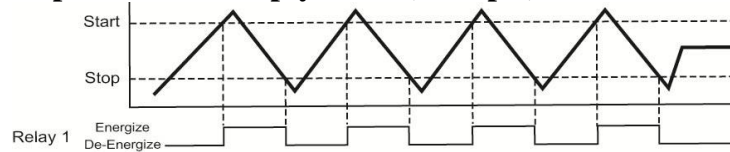

- **Lead/Lag** – Allows for the two relays to have unique start levels and a common stop level. The first relay will be identified as the lead relay and the second relay as the lag. Each time the lead level is reached, the first relay will always start. The lag relay will only start when the lag level is reached. All relays will stop at the common off level.

- **Lead/Lag used to Empty Tank (example)**

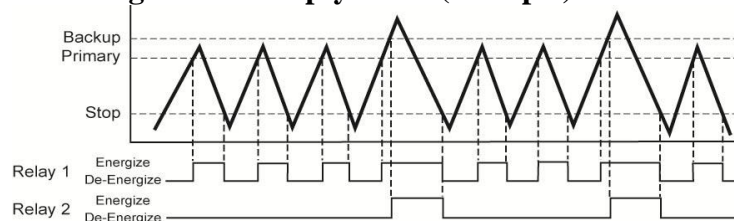

- **Duplex** - Allows for the two relays to have two different start levels, a common stop level and will alternate the relays when the first start level is reached. The two relays will alternate each time the lead level is reached and the remaining relay will start when the lag level is reached. All relays will stop at the common off level.

- **Duplex used to Empty Tank (example)**

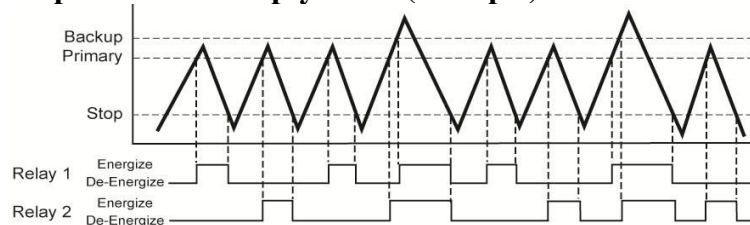

- **Not Applicable** – Appears when this function is not available (such as when *Switch/Alarms Only* or *4-20mA Transmitters Only* are selected).

Note: Right click on any menu that you may have questions on to open the help menu.

Note: To reset, press the Clear Screen button.

The screenshot shows a configuration window with two tabs: 'Configuration' and 'Updates'. The 'Configuration' tab is active. Below the tabs is a 'Config' section containing several dropdown menus. A red arrow points to the 'Relay Fail-Safe' dropdown menu, which is currently set to 'Pumps/Valves Off'. Other dropdown menus include 'Number of Pumps' (1-Pump/Valve), 'Pump/Valve Action' (Empties Tank), 'Pump/Valve Mode' (Simplex), 'Switch/Alarm Configuration' (-please select-), 'Switch Hysteresis/Deadband' (-please select-), 'Loop Fail-Safe' (-please select-), and 'Output at Empty' (-please select-). At the bottom of the configuration area, there is a text prompt 'Continue to select'.

Relay Fail-Safe

This feature allows you to select the fail-safe state for the relays. When the sensor regains signal, the output current will revert back to the current level condition.

- **Relays Off** - The relays will revert to the OFF state. Appears when **Switch/Alarms Only** is selected.
- **Relays On** - The relays will revert to the ON state. Appears when **Switch/Alarms Only** is selected.
- **Hold State** - The relay(s) will remain in the same state as the last echo detected. When the sensor regains signal, the relays will revert to the level when the signal was regain.
- **Pump/Valves Off** - The relays will revert to the OFF state. Appears when **1-Pump/Valve** or **2-Pumps/Valves** are selected.
- **Pump/Valves On** - The relays will revert to the ON state. Appears when **1-Pump/Valve** or **2-Pumps/Valves** are selected.
- **Not Applicable** – Appears when this function is not available (such as when **Transmitters Only** are selected).

Note: Right click on any menu that you may have questions on to open the help menu.

Note: To reset, press the Clear Screen button.

Configuration Updates

Config

Number of Pumps
1-Pump/Valve

Pump/Valve Action
Empties Tank

Pump/Valve Mode
Simplex

Relay Fail-Safe
Pumps/Valves Off

Switch/Alarm Configuration
1-Low, 1-High

Switch Hysteresis/Deadband
-please select-

Loop Fail-Safe
-please select-

Output at Empty
-please select-

Finish Selections

Switch/Alarm Configuration

This feature allows you to select the operation for the switches / alarms (used as a high or low alarm). This setting adjusts the number of available relays based upon the previous settings.

- **No Alarm** – Turns off all of the remaining relays.
- **High Alarm Options** – Set from 1 to 4 High Alarm (**1-High, 2-High, 3-High, 4-High**).
- **Low Alarm Options** – Set from 1 to 4 Low Alarms (**1-Low, 2-Low, 3-Low, 4-Low**).
- **Combination Alarms** – Set a combination of High and Low Alarms (**1-Low 1-High, 1-Low 2-High, 2-Low 1-High, 2-Low 2-High, 1-Low 3-High, 3-Low 1-High**).
- **Not Applicable** – Appears when this function is not available (such as when **Transmitters Only** is selected).

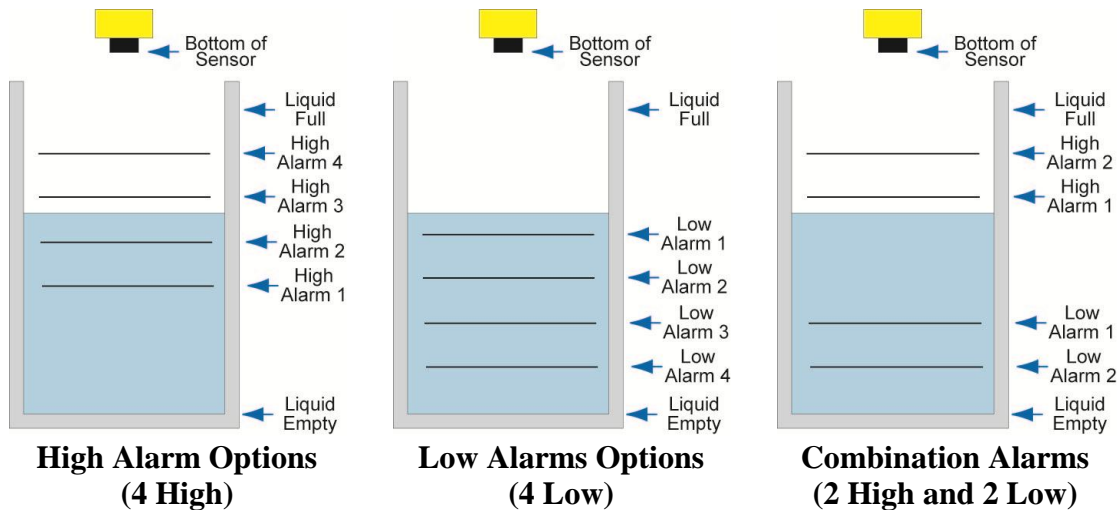

Note: Right click on any menu that you may have questions on to open the help menu.

Note: To reset, press the Clear Screen button.

FLOWLINE

Configuration Updates

Config

Number of Pumps
1-Pump/Valve

Pump/Valve Action
Empties Tank

Pump/Valve Mode
Simplex

Relay Fail-Safe
Pumps/Valves Off

Switch/Alarm Configuration
1-Low, 1-High

Switch Hysteresis/Deadband
Fixed 1/2"

Loop Fail-Safe
-please select-

Output at Empty
-please select-

Finish Selections

Switch Hysteresis/Dead band

This feature allows you to select a hysteresis or dead band for the remaining high and/or low alarms.

- **Options for Hysteresis/Dead band** – *No Hysteresis*, $\frac{1}{4}$ " , $\frac{1}{2}$ " , **1"** , **2"** , $\frac{1}{2}$ cm , **1cm** , **2 cm** , **5 cm** or *Not Applicable*.
- **High Alarms** – Relay activates above set point. Relay will deactivate when level goes below the set point plus the value of the hysteresis.
- **Low Alarms** – Relay activates below set point. Relay will deactivate when level goes above the set point plus the value of the hysteresis.

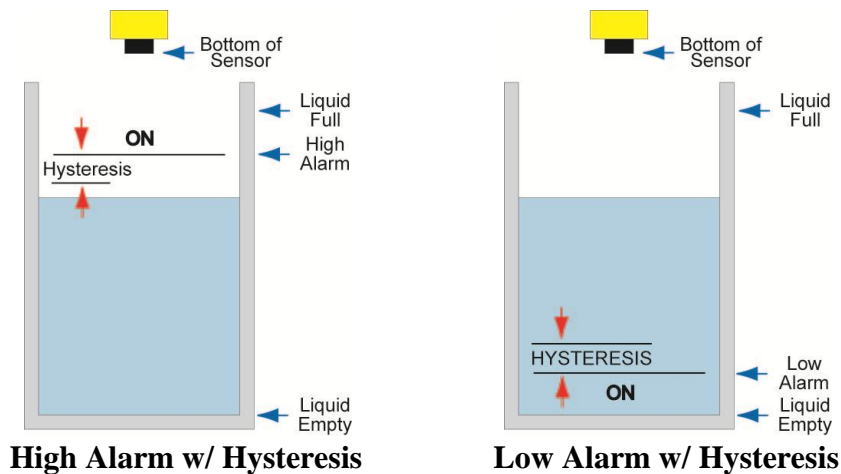

Note: Right click on any menu that you may have questions on to open the help menu.

Note: To reset, press the Clear Screen button.

The screenshot shows a configuration interface with two tabs: 'Configuration' and 'Updates'. Under the 'Configuration' tab, there is a 'Config' section with several dropdown menus. The 'Loop Fail-Safe' menu is set to 'Empty', and the 'Output at Empty' menu is set to '4 mA at Bottom'. Two red arrows point to these two menus. At the bottom left of the configuration area, it says 'Config #9'.

Loop Fail-Safe

This feature allows you to select the fail-safe current output if the sensor fails to detect a return signal. When the sensor regains signal, the output current will revert back to the current level condition.

- **Hold Last Value** - The output will remain in the same state as the last echo detected. Example: If the output was 6.7 mA just prior to the lost signal, the device will continue to output 6.7 mA. Sensor will indicate the level when signal was regain.
- **Empty** - The output will revert to the current value for an empty condition. When **4 mA at Bottom** is selected, the sensor will output 4 mA when a fail-safe condition occurs. If **20 mA at Bottom** is selected, the sensor will output 20 mA when a fail-safe condition occurs.
- **Full** - The output will revert to the current value for a full condition. When **4 mA at Bottom** is selected, the sensor will output 20 mA when a fail-safe condition occurs. If **20 mA at Bottom** is selected, the sensor will output 4 mA when a fail-safe condition occurs.
- **Overfill (21mA)** - The output current will go to 21mA when the return signal is lost.
- **Overfill (22mA)** - The output current will go to 22mA when the return signal is lost.

Output at Empty

This feature allows you to select the orientation of the 4 to 20mA output (4 to 20 mA or 20 to 4 mA). Choose which output setting best fits the application. Typical installations are set with **4 mA at Bottom**. This will not affect the performance of the sensor other than the output of the EchoPod. WebCal's factory default is 4mA at bottom and 20mA at top. *When connecting your sensor to a display, you must account for your output settings.*

- **4mA at Bottom** - The output current will be 4mA when the sensor measures an empty tank and 20mA when the sensor measures a full tank.
- **20mA at Bottom** - The output current will be 20mA when the sensor measures an empty tank and 4mA when the sensor measures a full tank.

Note: Right click on any menu that you may have questions on to open the help menu.

Note: To reset, press the Clear Screen button.

FLOWLINE

WebCal Step 2: Tank Levels

This section of WebCal is where you enter application measurement values. All values must be filled in before moving to step 3.

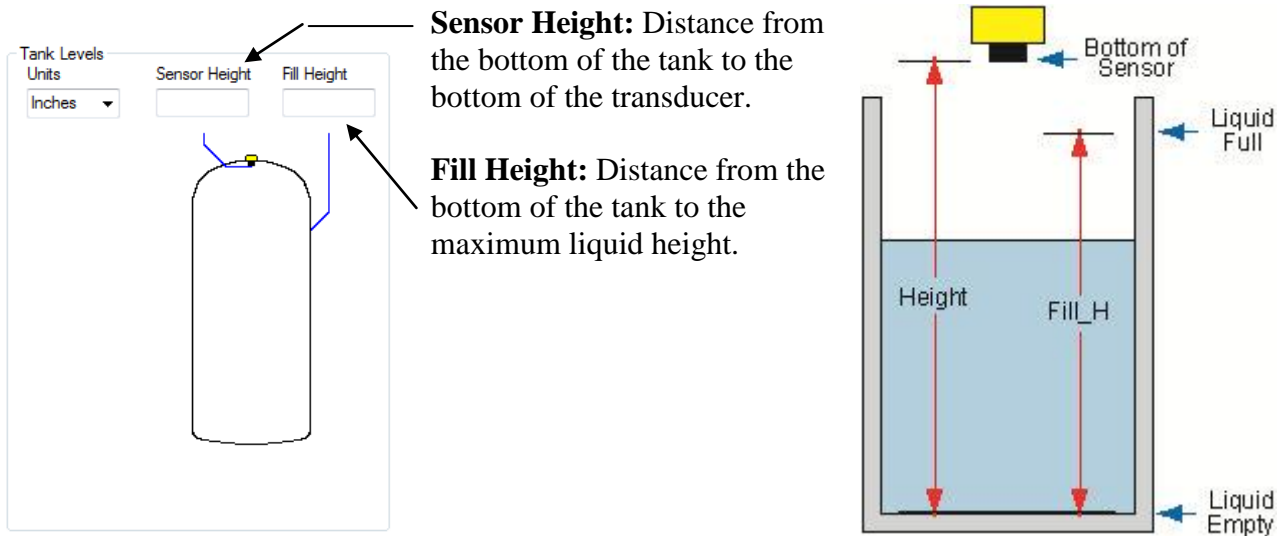

WebCal Step 3: Write to Unit

After you have entered configurations and tank values, click “**Write to Unit**” and send the configuration to your EchoPod. Now use WebCal’s file management features to save your configuration by clicking “**Save Config File**” and print your wiring diagram by clicking “**Wiring Diagram**.”

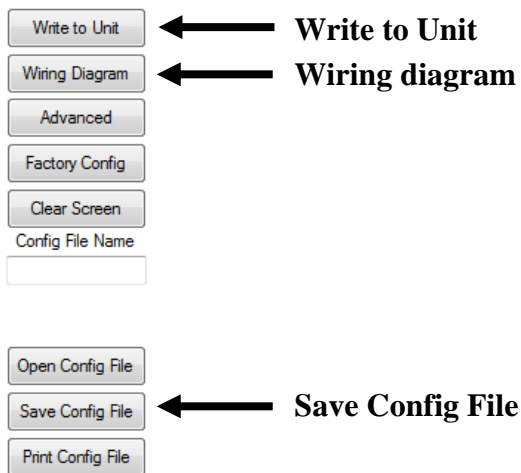

Wiring EchoPod

After you have finished positioning and mounting EchoPod, follow WebCal's wiring diagram to wire the sensor. A typical wiring diagram is shown above. Flowline recommends using a qualified licensed electrician to wire EchoPod and your application's components.

Note: Do not extend the White & Green wires beyond 15'.

Note: Configure your EchoPod with WebCal and use the wiring diagram button to view the appropriate diagram. Each configuration will have its own unique diagram. The diagram above is only a sample and should not be used as a wiring diagram.

Note: Once EchoPod is configured, isolate the white and green wires from active power to prevent a short of the configuration circuit.

Wiring Diagram

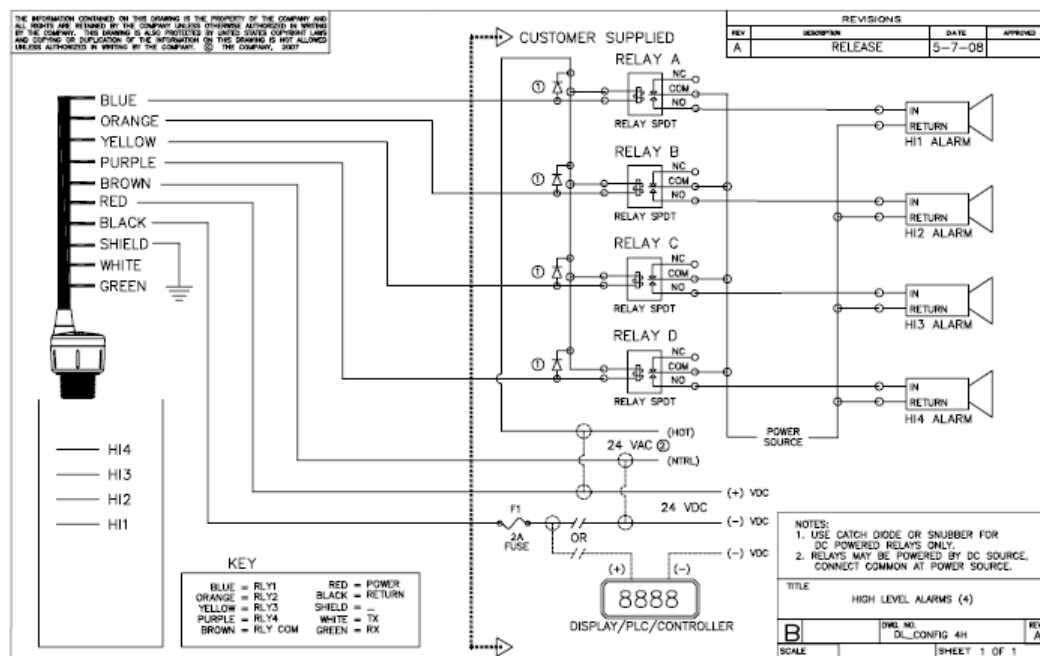

Sample Wiring Diagram – Use WebCal to view appropriate wiring diagram

Wire Connections:

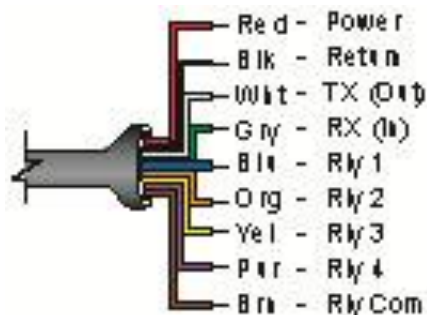

Red & Black

Red and Black leads are for connection to a 24 VDC power supply or to a 4-20 mA loop power source. The red and black wires can be extended up to 1,000 feet using a 22 gauge or larger wire, however do not extend the green and white wires.

FLOWLINE

White & Green

White and Green leads are reserved for use with WebCal and should not be connected during usage in the application. These wires should not be connected to WebCal while power is supplied from any source other than the LI99 series Fob.

Never allow the white or green wires to touch any power supply.

Blue, Orange, Yellow & Purple

Blue, Orange, Yellow & Purple wires are the relay contacts (normally open) from each of the relays respectively. Relay selection is determined by the configuration in WebCal.

Brown

The Brown wire is the common for all the relays.

General notes for electrical connections, usage and safety:

- Where personal safety or significant property damage can occur due to a spill, the installation must have a redundant backup safety system installed.
- Wiring should always be completed by a licensed electrician.
- Supply voltage should never exceed 28 VDC.
- Always use stepper relays between the sensor and external loads. For DC circuits use a catch diode such as 1N4148, shown on previous page.
- Protect the sensor from excessive electrical spikes by isolating the power, whenever possible.
- The sensor materials must be Chemically compatible with the liquids to be measured.
- Design a fail-safe system for possible sensor and/or power failure.
- Never use the sensor in environments classified as **Hazardous**.

4-20 mA output only

EchoPod can be used as a loop powered 4-20 mA only device (refer to the wiring diagram below). When using WebCal, under *Number of Pumps*, select *4-20mA Transmitter Only* to simplify the configuration in WebCal.

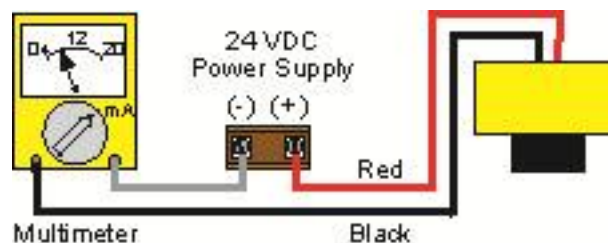

Voltage Output

EchoPod can be used as a 0 to 5 or 0 to 10 VDC output device. A resistor will need to be added to the circuit to enable a voltage output (refer to the wiring diagram below).

- 0-5 VDC output
 - Add a 250 Ohm resistor
 - Actual output will be 0.8 to 5 VDC
- 0-10 VDC output
 - Add a 500 Ohm resistor
 - Actual output will be 2 to 10 VDC

When using WebCal, under **Number of Pumps**, select **4-20mA Transmitter Only** to simplify the configuration in WebCal.

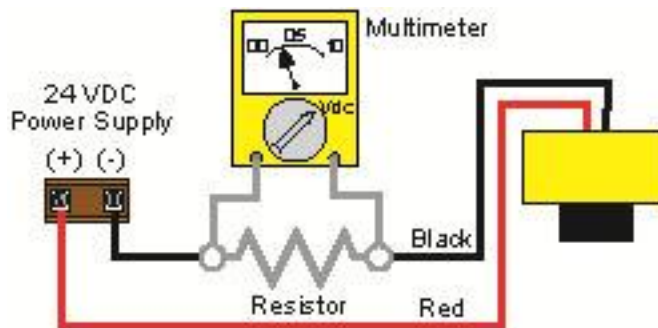

Installation

The EchoPod should always be mounted perpendicular to the liquid surface and installed using the provided Viton mounting gasket. Make sure that the fitting and transmitter threads are not damaged or worn. Always *hand-tighten* the transmitter within the fitting. Perform an installed leak test under normal process conditions prior to system start up. **Note:** *The preferred mounting fitting for the DL14 and DL24 series is the LM52-1400 (2" thread x 1" thread) reducer bushing.*

Mounting Guide

1. Do not mount at an angle
2. Liquid should never enter the dead band
3. Side Wall:
 - a. For DL14 & DL24 Series - mount at least 2" from the side wall
 - b. For DL34 Series - mount at least 3" from the side wall
4. Do not mount where obstacles will intrude on sensor's beam width
 - a. See Specifications on page 8
5. Do not mount in a vacuum
6. Avoid mounting in the center of a dome top tank.
7. In cone bottom tank, position the sensor over the deepest part of the tank.

FLOWLINE

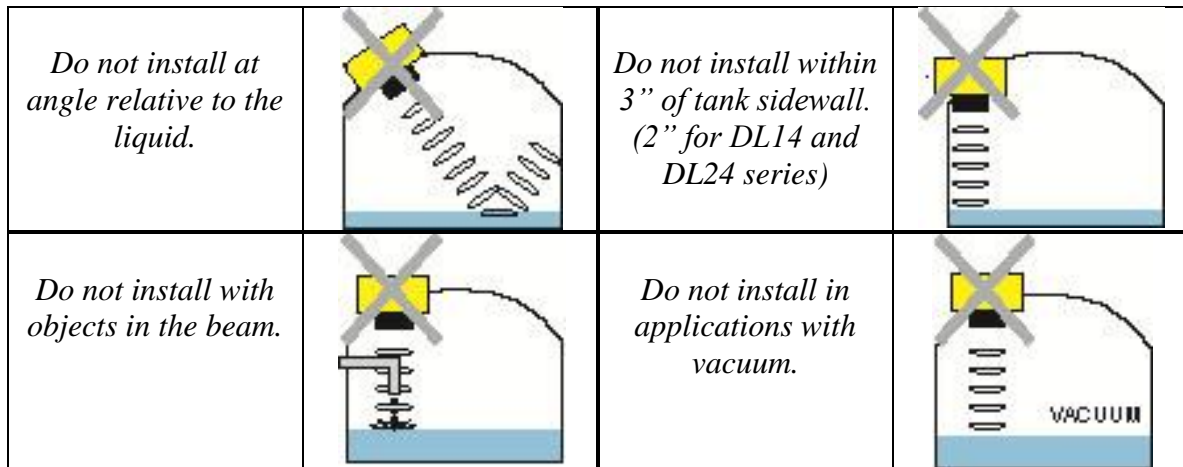

Installation in existing fittings

If the existing fitting is larger than the threads of the EchoPod, select a reducer bushing such as the LM52-1400 (2" thread x 1" thread) or LM52-2400 (3" thread x 2" thread).

Metal Tanks (DL14 & DL24 series)

Flowline ultrasonic transmitters have been optimized for use in non-metallic fittings.

1. For best performance, avoid the use of metallic fittings.
 - a. Use a plastic 2" x 1" reducer bushing, such as the LM52-1400 or a plastic 1" flange, such as the LM52-1850 for metallic tanks.
2. While installations directly into a 1" metal fitting are not recommended, acceptable results may be obtained if the 1" fitting is a half coupling in form and the outer diameter of the coupling is tightly wrapped in vinyl tape to dampen vibrations.

Fitting Selection: Check the part number to determine the required fitting mount size and thread type. EchoPod is commonly installed in tank adapters, flanges, brackets or standpipes. Note: Always include the gasket when installing the EchoPod.

1. **Tank Adapter:** Select a tank adapter fitting, such as the LM52-1890 for the DL14 & DL24 series or the LM52-2890 for the DL34 series.
 - a. *For best results, select a 2" tank adapter and add a reducer bushing such as the LM52-1400, thread x thread, reducer bushing.*
 - b. Avoid tank adapter (thread x thread) styles and/or pipe stops forward of the installed transducer.

**Tank Adapter
w/ 2"x1" Reducer Bushing**



**Tank Adapter
Thread x Thread**



Do not use thread x thread

2. **Riser:** Installations with tall, narrow risers can impede the acoustic signal.
 - a. **DL34 Series:** 2" (5 cm) diameter risers should be no taller than 5" (12.7 cm). Larger diameter risers should be no taller than 12" (30.5 cm).
 - b. **DL14 & DL24 Series:**

	Riser Specifications	
	Inner Diameter	Maximum Height
2" (5 cm)	3" (7.6 cm)	
4" (10 cm)	6" (20 cm)	
6" (15 cm)	12" (30 cm)	

Note: Do not exceed the dimensions listed above

3. Flange (DL14 & DL24 series):

If installing on a flange, select a flange with a thread that is above the plane of the flange, such as the LM52-1850.

- a. *The DL34 series works well with Flange installations.*
- b. Avoid the use of blind flanges with tapped threads or flanges where the threads are even with the plane of the flange, such as the Banjo 1" Poly ANSI Flange (series AF100).
- c. Use a flange with a 2" thread and add a 2" to 1" reducer bushing to complete the installation.

**1" Flange w/
thread in plane**



Do not use thread in plane

**2" Flange w/
reducer bushing**



4. Side Mount Bracket:

For installations in open tanks and sumps, use the LM50 series side mount bracket.

- a. For the DL14 & DL14 series, order the LM50-1001-1, which includes a 2"x 1" Reducer Bushing.
- b. For the DL34 series, order the LM50-1001 side mount bracket.

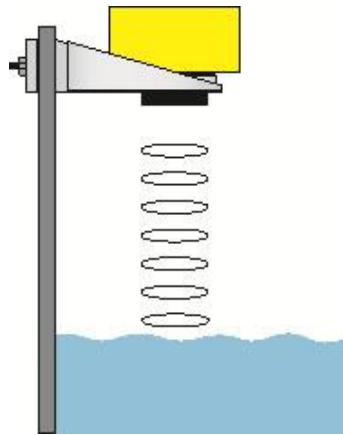

5. Stand Pipe:

A standpipe maybe used to dampen turbulence or when foam is present in the application.

- a. Pipe can be made of any material.
- b. Select a minimum 3" ID pipe for the stand pipe.
 - i. A 2" pipe is usable with the DL14 and DL24 series, but is the minimum.
 - ii. Pipes larger than 3" can also be used.
- c. Use a coupling and reducer bushing to attach the EchoPod to the pipe.
 - i. With the DL14 & DL24 series, be sure to use a plastic reducing bushing such as LM52-1400 2" T x 1" T fitting or the LM52-1410 2" S x 1" T fitting.
- d. The pipe length should run the measurement span and the bottom of the pipe should remain submerged at all times to prevent foam from entering the pipe.
- e. Cut a 45° notch at the bottom of the pipe and drill a 1/4" pressure equalization hole in the dead band.
- f. The pumps should not drive liquid past the open end of the stand pipe which causes the liquid in the pipe to oscillate.

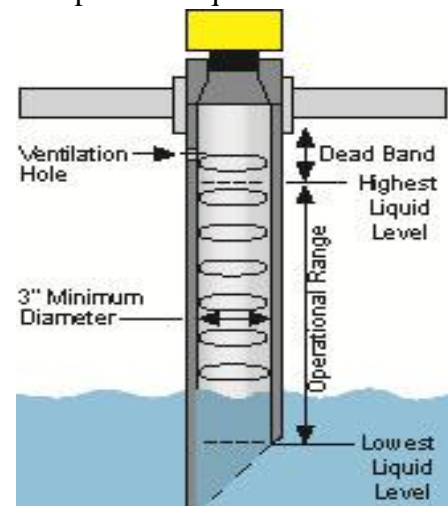

Advanced Features

This tool is designed to help solve operational issues. Changing these setting will alter the performance of your unit. Please read through this HELP file to assist you in making adjustments or if still unclear about a specific issue, please contact FLOWLINE, Applications Engineering.

The screenshot shows the FLOWLINE configuration software interface. At the top, there are two tabs: 'Configuration' and 'Updates'. The 'Configuration' tab is active. The interface is divided into several sections:

- Config:** A list of configuration options, each with a dropdown menu. The options are: Number of Pumps (4-20mA Transmitter Only), Pump/Valve Action (Not Applicable), Pump/Valve Mode (Not Applicable), Relay Fail-Safe (Not Applicable), Switch/Alarm Configuration (Not Applicable), Switch Hysteresis/Deadband (Not Applicable), Loop Fail-Safe (Hold Last Value), and Output at Empty (4 mA at Bottom).
- Part Information:** Part Type: DL24-0, Serial Number: 1065, Firmware: LC2p50, Description: Switch, Cont & Trans, 98.4"(2.5m), 4 relays, FW Rev: 46.3.
- Tank Levels:** A section with a 'Units' dropdown (Inches), a 'Sensor Height' input field (90), and a 'Fill Height' input field (86). Below this is a diagram of a tank with a sensor at the top and a fill line. A red arrow points to the 'Advanced' button in the right-hand menu.
- Right-Hand Menu:** A vertical stack of buttons: Write to Unit, Wiring Diagram, Advanced (highlighted with a red border), Factory Config, Clear Screen, Config File Name (input field), Open Config File, Save Config File, and Print Config File.
- Notes:** A text area at the bottom for entering notes.

Note: When the Advanced Button is highlighted with a RED border, this indicates you have selected an advanced feature.

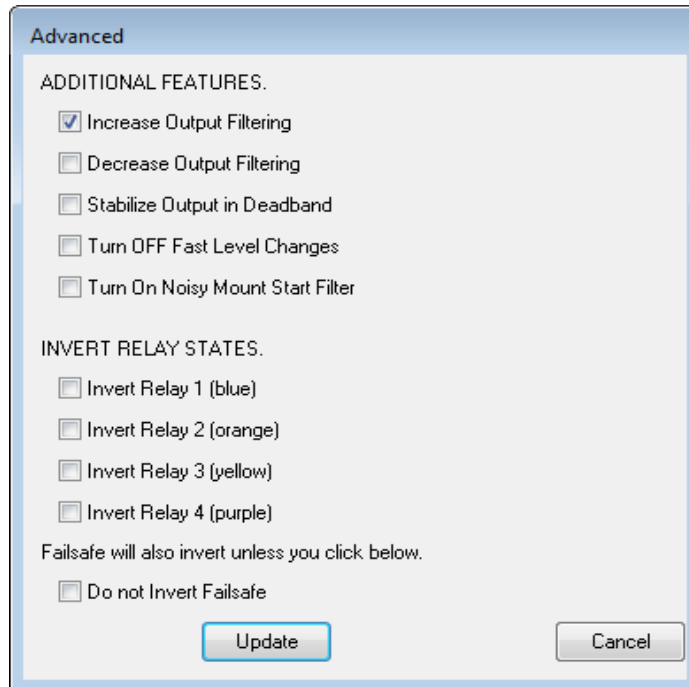

- **Increase Output Filtering:** Placing a check mark in the box will increase the filtering (averaging) of the analog output. Use this filter if the 4 to 20 mA output requires a smooth output for the application such as open channel flow measurement.
 - **Decrease Output Filtering:** Placing a check mark in the box will eliminate all filtering (averaging) of the analog output. Enables a pulse by pulse level reading. Use this filter to see changes in level after every sound pulse.
- Note: Never check increase output filtering and decrease output filtering at the same time.*
- **Stabilize Output in Deadband:** Placing a check mark in the box will activate a filter to hold the output at Full if the level enters the dead band of the EchoPod. This filter requires the level to leave the dead band at a smooth and steady rate.
 - **Turn OFF Fast Level Changes:** Placing a check mark in the box will turn off the filter enabling fast level changes. Use this filter if your application has very smooth, slow and steady level changes. The filter instructs EchoPod to look only for small incremental changes in level.
 - **Turn ON Noisy Mount Start Filter:** Placing a check mark in the box will activate a filter that reduces sound interference from the installation mount. Use this filter if the EchoPod will not go to full range in the installation.
 - **Invert Relay States:** Placing a check mark in any of the four boxes will reverse the state of that relay. For example, if relay 4 is a high alarm that energizes above 50.0” of liquid, checking the invert box will reverse so the relay will energize when it is below 50” of liquid. Inverting the relay will also invert the fail-safe of the relay. If the relay is fail-safe On, Inverting the relay will make it fail-safe Off.
 - **Fail-Safe will also invert unless you check below:** This button will not invert the fail-safe when a relay is inverted.

Appendix

Updating WebCal Software

WebCal software can be updated directly from the software. Simply click on the **Updates** Tab at the top of the window and press the **Download** button. Make sure that your computer has access to the Internet. If not, an error window will appear.

When the **Download** button is pressed, the software will check the version of software you are using with the most recent version at Flowline. If the versions are similar, a window indicating that the most recent version is installed. If not, then a window will appear asking to download the latest version. Follow the instructions for installing the latest version.

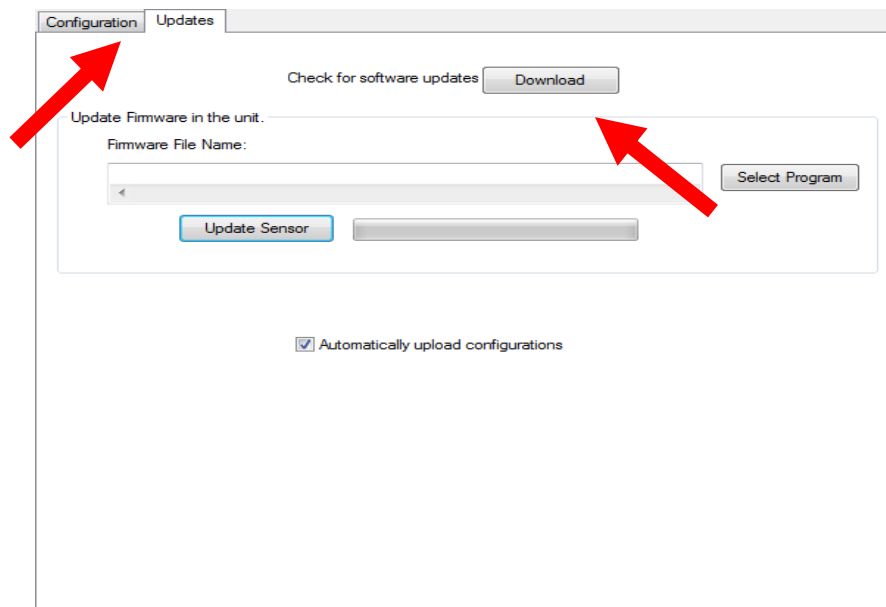

Updating Transmitter Firmware

WebCal software can also be used to update firmware inside the EchoPod transmitter. This feature allows the transmitter to be updated when new features are added. First open WebCal with an EchoPod transmitter connected and the latest version of WebCal installed to your PC.

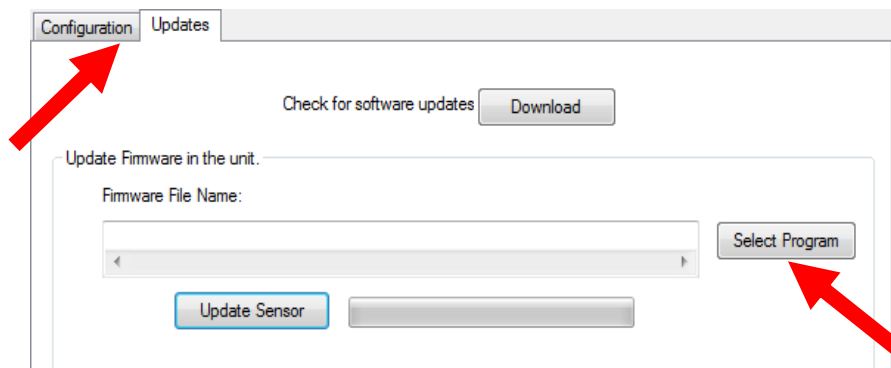

Click on the **Updates** Tab and then click on **Select Program** to select the firmware update.

FLOWLINE

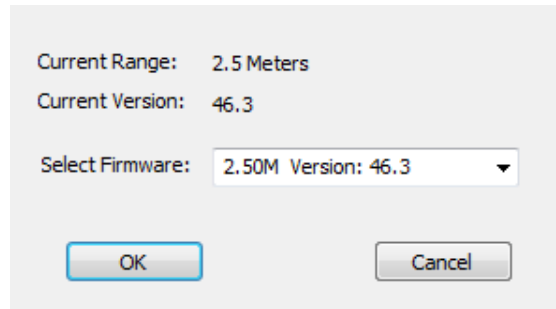

Select the latest version of the firmware file and click on OK.

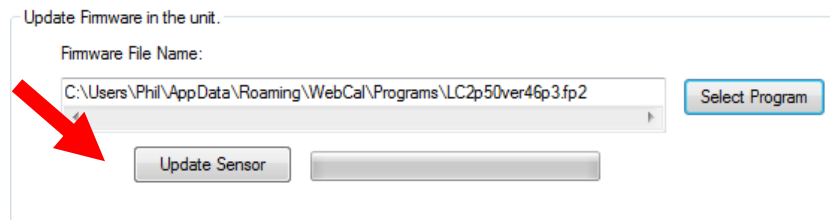

Confirm that the address is correct and then click on **Update Sensor** to begin the firmware update. This step should take less than 1 minute. You can follow the progress with the status bar to the right of the Update Sensor button. When completed, click on the Configuration tab to configure the transmitter. *Remember, when the firmware has been updated, the unit will return to its original factory settings.*

- If there is a communication interruption during the update, the process will stop. It is OK to click on Update Sensor again to start the process over again.

Factory Default

Pressing the **Factory Config** button in the Configuration menu will return the screen to the following settings. Out of the box, the EchoPod will output a 4-20 mA output that is maximized for its operational range.

- **DL14 Series** – 4mA @ 4.1' (1.25m) away and 20 mA @ 2" (5cm) away from sensor.
- **DL24 Series** – 4mA @ 8.2' (2.5m) away and 20 mA @ 4" (10cm) away from sensor.
- **DL14 Series** – 4mA @ 18.0' (5.5m) away and 20 mA @ 8" (20cm) away from sensor.

Factory Defaults Table

Configuration Updates

FLOWLINE

Part Type: DL24-0, Serial Number: 1065 Firmware: LC2p50
Description: Switch, Cont & Trans, 98.4"(2.5m), 4 relays FW Rev: 46.3

Config

Number of Pumps
Switch/Alarms Only

Pump/Valve Action
Not Applicable

Pump/Valve Mode
Not Applicable

Relay Fail-Safe
Relays Off

Switch/Alarm Configuration
4-High

Switch Hysteresis/Deadband
No Hysteresis

Loop Fail-Safe
Hold Last Value

Output at Empty
4 mA at Bottom

Config #40

Tank Levels

Units	Sensor Height	Fill Height
Inches	98.4	94.4
Hi-4	85.0	
Hi-3	16.0	
Hi-2	12.0	
Hi-1	8.0	

Write to Unit

Wiring Diagram

Advanced

Factory Config

Clear Screen

Config File Name

Open Config File

Save Config File

Print Config File

Notes

Testing the Transmitter

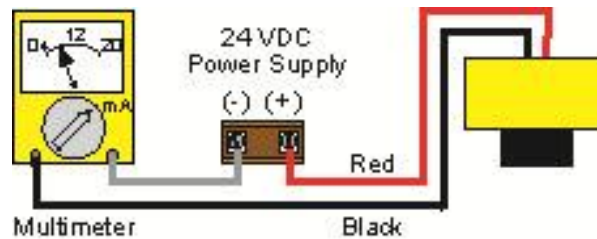

1. Connect a multimeter in series with the black wire to read the current output.
2. Verify that the current increases (tank filling) and decreases (tank emptying) appropriately in the calibrated span.
3. If not, carefully observe and attempt to correlate any installation, level or application event for more specific troubleshooting direction.

Troubleshooting

PROBLEM	SOLUTION
Transmitter indicates a current of 0 mA	Check the wiring for an open circuit. An open circuit is the most common issue with a 0 mA signal.
Transmitter jumps to a current reading between 19 and 20 mA	Check the installation of the transmitter. Bad installation fittings will cause false signals near the top of the tank, which typically translates to a signal between 19 and 20 mA. Also look for interference just below the transmitter. If the transmitter is installed in a metal fitting, switch to a plastic fitting.
Transmitter indicates a current over 23 mA	Immediately check the wiring for a short circuit. The EchoPod is current limited to 22 mA. Anything above 23 mA indicates a short circuit.
Transmitter always jumps to the LOST condition	Check the dimensional configuration (Height and Fill-H) of the EchoPod. Make sure that the Fill-H setting corresponds to the full level of liquid (from the bottom up) and not the distance from the transmitter to the liquid (top down).
Output of transmitter is opposite of the level of liquid	Check the Output at Empty Setting. Make sure the setting is correct (<i>4mA at bottom</i> or <i>20 mA at bottom</i>).
No Unit Detected in WebCal	WebCal cannot detect an EchoPod connected to the computer. <ul style="list-style-type: none"> • Check that the Fob is connected to the USB port. • Check that all four wires (Red, Black, White and Green) are securely attached to the Fob. • Check in Device Manager that both drivers (WebCal Configuration & EchoFob) are present.
Internet error. The server name or address could not be resolved.	This is a warning indicating the computer configuring EchoPod is not connected to the internet. Click OK to continue. Flowline recommends being connecting to the internet for all configurations. Not being connected to the internet will not prevent the EchoPod from being configured.
Cannot access some of the features in Configuration	As choices are made in Configuration, WebCal will begin to eliminate functions that are no longer active. To reset Configuration or get access to all the features, click on the Clear Screen button.
Relay closes, but does not open again	An inductive kick may be holding the relay closed. If switching 24 VDC, make sure a diode has been installed to act as a snubber (see page 21 and 22).
Relay chatters on and off repeatedly	Most likely the turbulence in the tank is causing the chatter. Increase the Hysteresis setting to correct.